

Data Sheet



Article number: 604133036040

Description: Taper bored timing belt pulley
HTD 36 14M 40 TL 2517

Measures

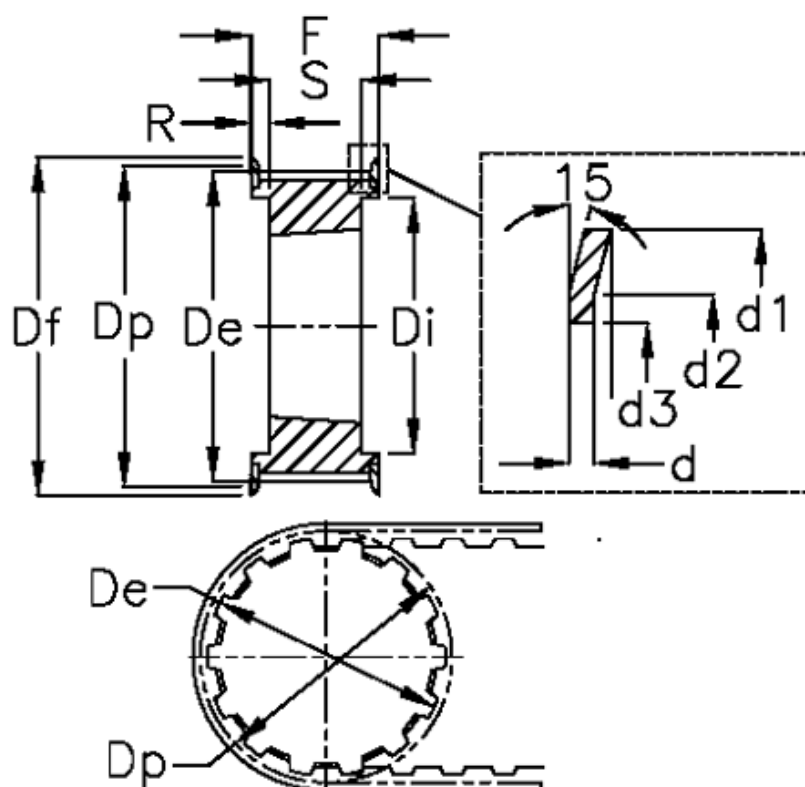

d = 2.5	F = 54	Weight = 4.8
d1 = 168	Flange type = F52	Width = 40
d2 = 161	For bushing = 2517	
d3 = 148	Max bore = 60	
De = 157.68	r = 4.5	
Df = 168	S = 45	
Di = 120	Tooth number = 36	
Dp = 160.43	Type = 14M	